

SOPORTE DERECHO

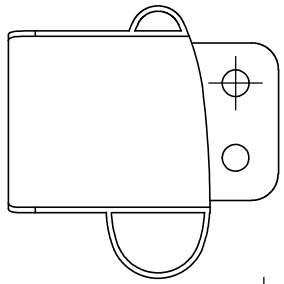

04FT6308-6

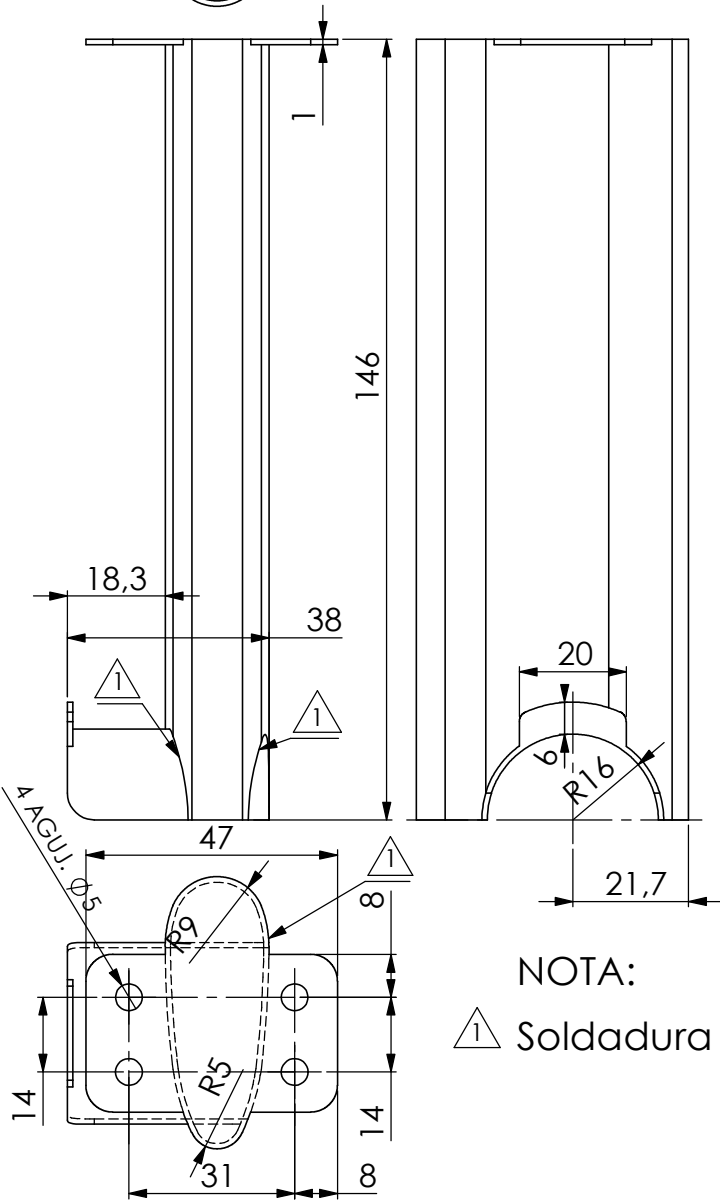
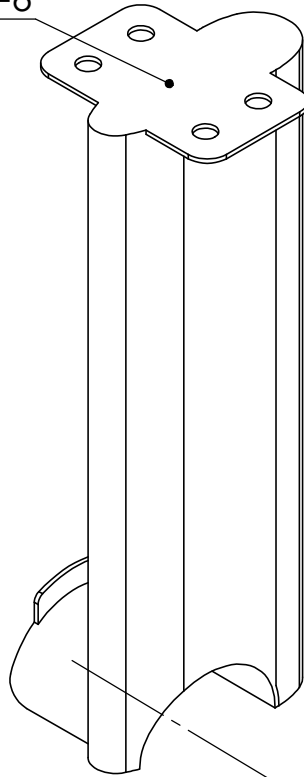

Reemplaza a:

REV	FECHA	MOTIVO	APROBADO
○			
○			
○			

SOPORTE IZQUIERDO

Chapa AISI 304 esp. 1mm

Perfil fuselado 15000-AR

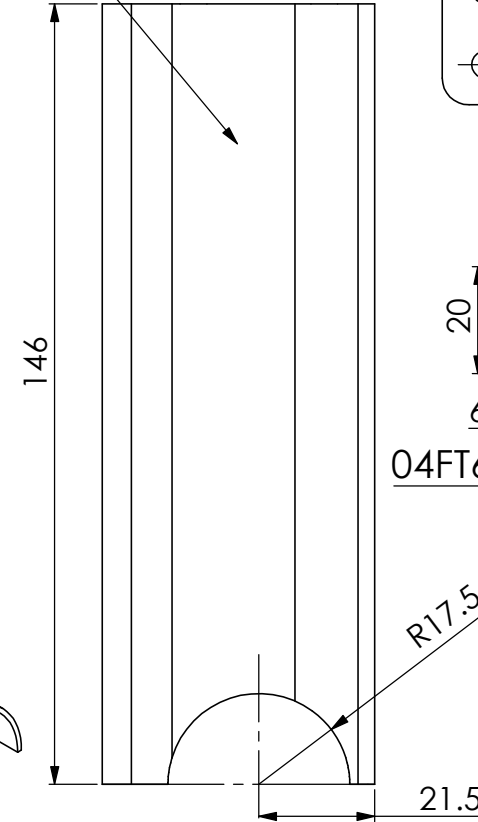
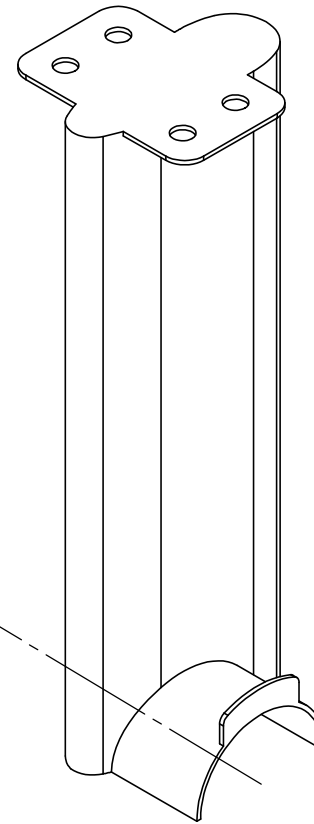
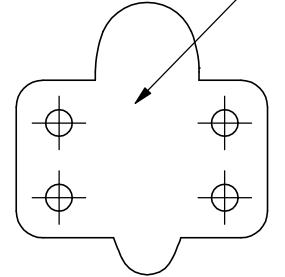
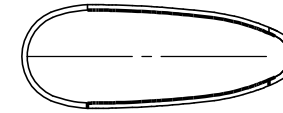

Rug. Grad:	Trat. Térmico:	Esc:	Fecha:	Nombre:	Material:
~	-	2:1	18/06/25	B. Moreira	Acero Inox. 304
	Trat. Superf:	1:1	Revisó:	B. Moreira	Cantidad: 1 p/Lado
	-	1:5	Aprobó:	B. Moreira	

 Durrigo 651
 2600-Venado Tuerto
 ARGENTINA
 Tel.+54 3462 43254
 Fax.+54 3462 43833

TOLERANCIA GENERAL		N/A	
Ángulos	≤ 30°	30° a 120°	> 120°
	15°	30°	1°
Diámetro	0-6	6-30	30-120
	±0,03	±0,05	±0,10
Largo	±0,30		

SOPORTES DE FILTRO "T" EXT. (Tubo Redondo)

N° de Parte:	64123-11-AR
Archivo:	64123-11-AR.dwg
Fecha de emisión:	18/06/2025
Reemp. a:	--
REV.	<input checked="" type="checkbox"/> 1 <input type="checkbox"/> 2 <input type="checkbox"/> 3 <input type="checkbox"/> 4